

CERAMIC JAB-IN™ FULL SIZE THERMOCOUPLE CONNECTOR

- **2-POLE**
- **ONE-PIECE BODY**
- **JAB-IN™ WIRE HOOK-UP**
- **CERAMIC CONSTRUCTION**
Utilization Temperature to 1000°F(538°C)
- **SUITABLE FOR VACUUM USE**

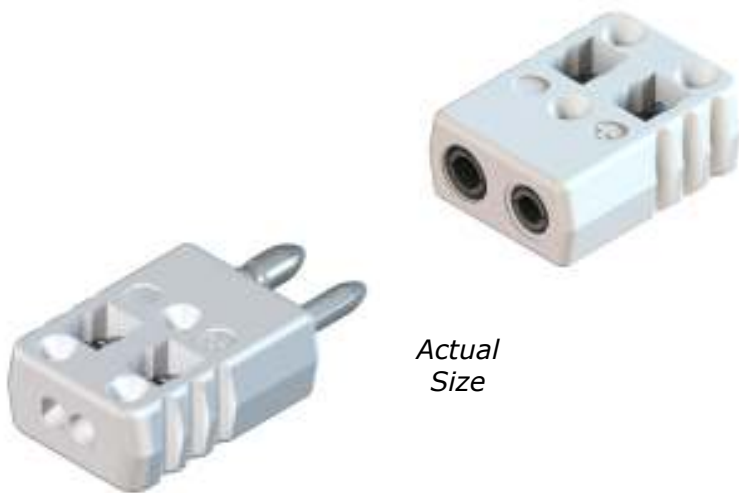

Marlin Manufacturing
Corporation

© Marlin 2011

12800 Corporate Drive
Cleveland, OH 44130

216-676-1340 800-321-6648 USA
216-676-1344fax sales@marlinmfg.com

Wires Jab-In™ for quick reliable hook-up of wires to 14 gage (0.064"). Strip approximately 1/2"

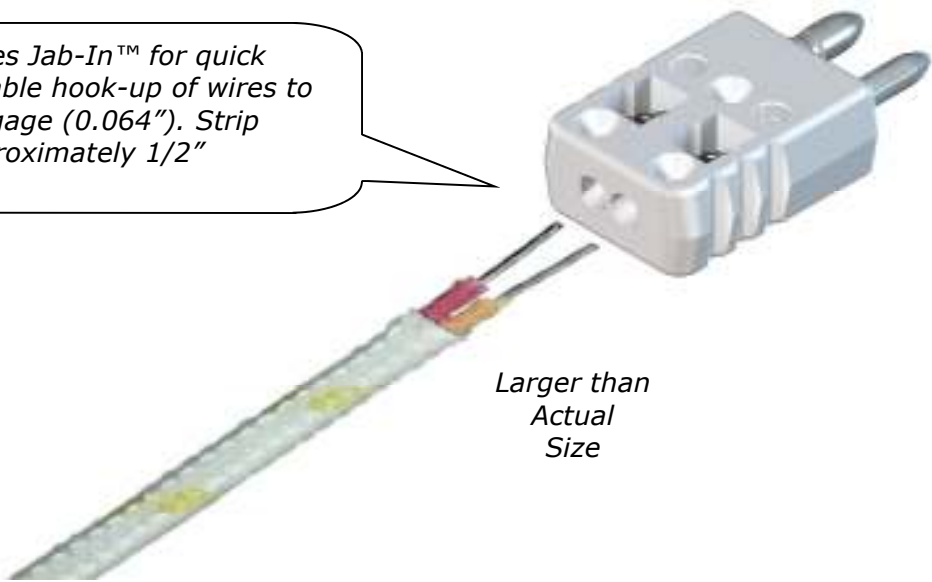

Larger than Actual Size

Standard Full-Size Mounting Hardware fits both Plug and Jack



1082 Wire Clamp

Soft Insulated thermocouple alloy wire can be strain relieved and held secure via optional adapters



1086 Cable Clamp



1074 Crimp Adapter

MIMS (Mineral Insulated Metal Sheath) Thermocouple can be secured via optional crimp or compression adapters



1072 Compression Adapter

SPECIFICATIONS

APPLICATION:

Intended for convenient plug-in connections of thermocouples and thermocouple extensions.

PURPOSE:

To maintain the integrity of thermocouple circuits by utilizing proper thermocouple alloys and wiring techniques.

DESCRIPTION

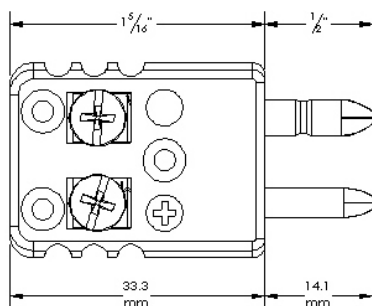

- 2-POLE - Conforms to ASTM E 1129 Dimensional Requirements
- STANDARD (ROUND PINS: Tubular or Solid)
- COMPATIBLE ALLOY CIRCUITRY
- ONE-PIECE BODY
- JAB-IN WIRE HOOK-UP: SS COMPONENTS (up to 14 gage (0.064"))
- CERAMIC CONSTRUCTION
 - Utilization Continuous Use Temperature to 1000°F (538°C)
(Limitation of Spring Contacts)
 - Intermittent Temperature Limit 1200°F (649°C)
(Depending On Atmosphere)
 - Suitable for Vacuum use
 - Approximate Ceramic Melting Temperature (N/A—WILL NOT MELT)
- WHITE CERAMIC COLOR
- THERMOCOUPLE TYPE DESIGNATION ON BODY
- POLARITY MOLDED INTO BODY

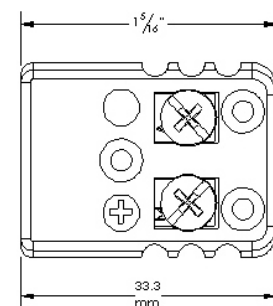
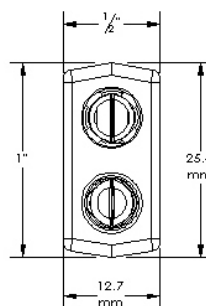

Plug Jab-In Ceramic
42C1XX00 Tubular Pins
42C4XX00 Solid Pins
XX= Type Designator



Jack Jab-In Ceramic
45C1XX00
XX= Type Designator

DESCRIPTION	TYPE	CODE	PRICE
PLUG CERAMIC JAB-IN 	T J E K N RX SX CX U	42C10100 42C10200 42C10300 42C10400 42C10500 42C10600 42C10700 42C11200 42C10900	\$7.25/EA
PLUG CERAMIC JAB-IN SOLID PIN 	T J E K N RX SX U	42C40100 42C40200 42C40300 42C40400 42C40500 42C40600 42C40700 42C40900	\$9.25/EA
JACK CERAMIC JAB-IN 	T J E K N RX SX CX U	45C10100 45C10200 45C10300 45C10400 45C10500 45C10600 45C10700 45C11200 45C10900	\$8.00/EA

QUANTITY	DISCOUNT
<25	NET
>25<100	0.90
>100	0.80