

1260/1210
1360/1310
MINI 2-POLE
ASTM/IEC/DIN/JIS

MARLIN MINIATURE 2-POLE THERMOCOUPLE CONNECTOR

- 2-POLE MINIATURE
- PATENTED (US 3855569)
- JAB-IN WIRE CONNECTIONS
- HEX-BODY STRAIN RELIEF
- THERMOSET CONSTRUCTION
(will NOT melt)(LOW out-gassing)
- ASTM/IEC/DIN/JIS COLOR CODE

1260 / 1210

Utilization Temperature Range:400°F(205°C)

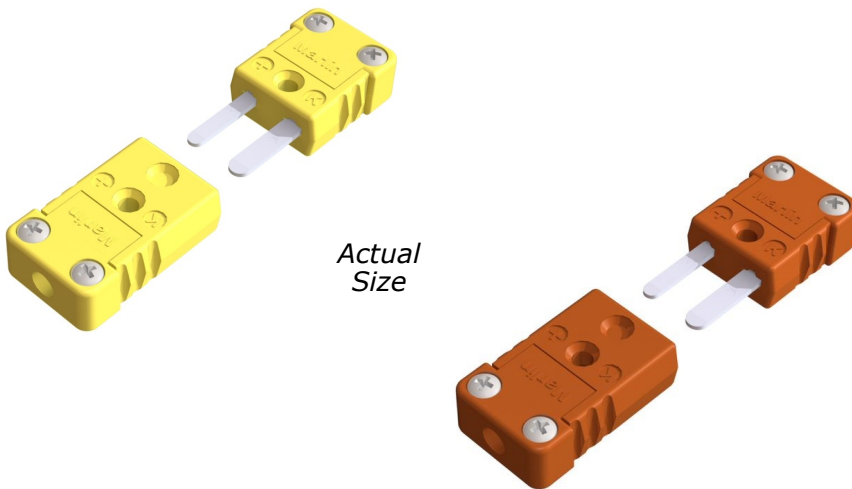

1360/1310 HIGH TEMPERATURE

Utilization Temperature Range:800°F(425°C)

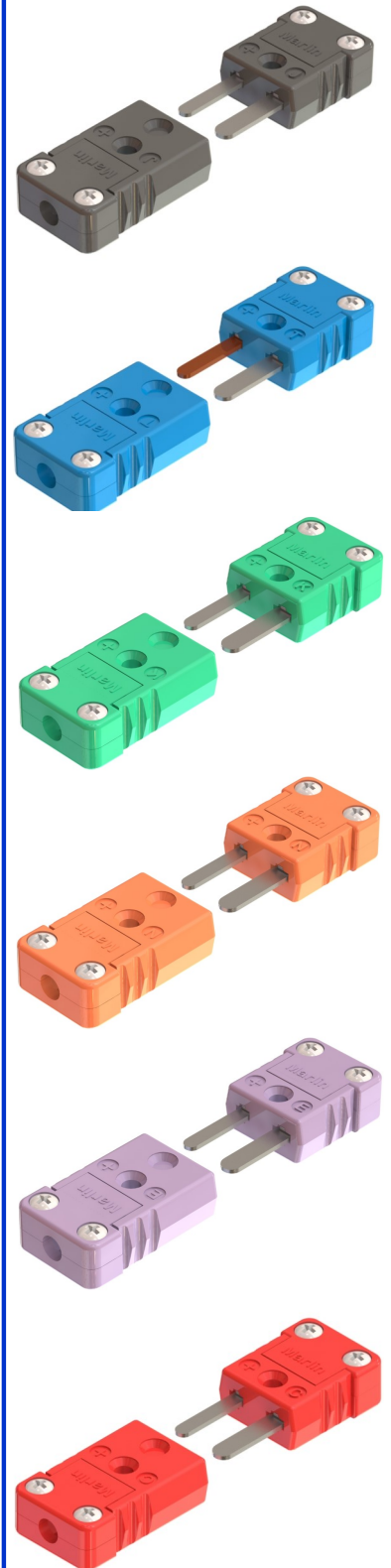

Marlin Manufacturing
Corporation

© Marlin 2024

12800 Corporate Drive
Cleveland, OH 44130

216-676-1340 800-321-6648 USA

THEORY OF OPERATION

APPLICATION: Intended for convenient plug-in connections of thermocouples and thermocouple extensions. Ideal for small diameter MIMS and fine wire.

PURPOSE: To maintain the integrity of thermocouple circuits by utilizing proper thermocouple alloys and wiring techniques. Use for thermoelectric circuits consistent with millivolt (mV) requirements per ASTM E 1684.

NOT FOR USE IN ELECTRICAL APPLICATIONS AC OR DC.

A thermocouple is a pair of dissimilar wires joined as to produce a thermally generated emf when its ends are at different temperatures. Several combinations of dissimilar pairs have become standardized and used in temperature instrumentation. T, J, K, N, R, S, B, are letter codes designating some popular thermocouple materials that are readily available. Each combination has its own unique emf output and metallic properties that make them applicable for a particular use. Thermocouple theory allows the extension of the wires without affecting its emf output when the extension wire and connectors have the same thermoelectric characteristics. For example, when a "K" type thermocouple is being used the wires and connectors used to extend it must be also type "K". The types have assigned color codes, for instance, "K" type has yellow code for the USA. This code allows for easy identification so as to help prevent mismatching of extension wires, connectors, and thermocouples. For example, if in the yellow color code of the type "K" circuit a blue type "T" connector would be an obvious improper component.

The generalized thermocouple system may be divided into five basic areas: Hot-Zone; Gradient Area; Extension Region; Reference Junction; and Readout. The extension region is generally where thermocouple connectors are utilized in order to facilitate thermocouple-to-readout hook-up. In a simplistic and isolated system the thermocouple will perform to specifications. Thermocouple connectors and panels are polarized making them virtually impossible to miss-mate positive and negative thermocouple legs. Wiring a positive-to-negative and then a negative-to-positive down line is called a double reversal and is NOT desirable because it will give false temperature readouts. Marlin's connectors and panels are molded from glass reinforced thermoset compounds for high strength and dependability. They WILL NOT MELT and are rated for continuous use to 400°F (205°C) and 500°F (260°C) intermittently and high-temp 800°F (425°C) and 1000°F (538°C) intermittently. They are color coded and letter coded for type and polarization identification (high-temp are molded in HTRED only). Current (mV) carrying metal parts are made of alloys matching the characteristics of the T/C type with which they are intended to be used. Contact springs are non-magnetic, non-corrosive and specially selected and processed to withstand the rated operating conditions.

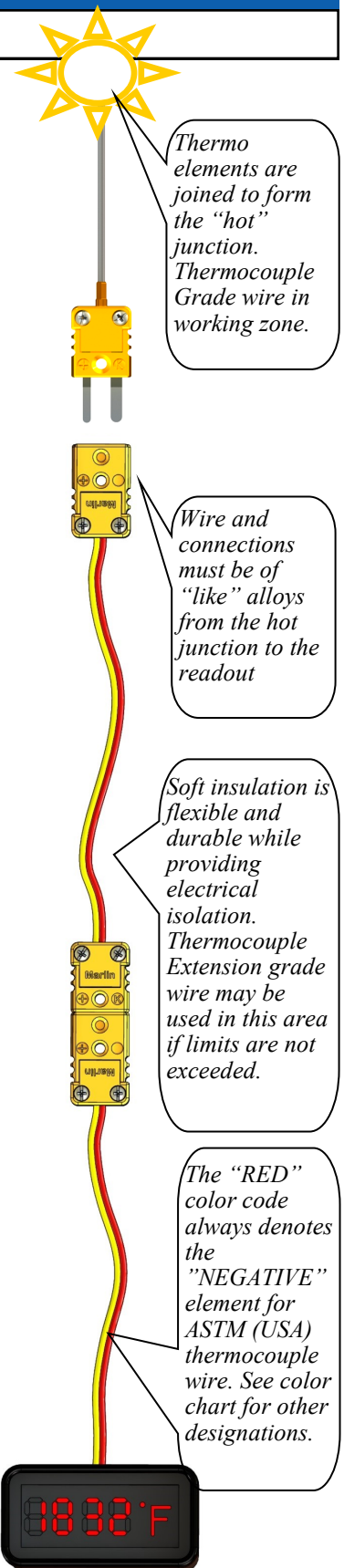

Molded of glass-filled thermoset compound that WILL NOT MELT. Polarity and Thermocouple-Type designations on the one-piece body.

Alloy plates are designed to clamp wire without stress

Actual Size



Pins are alloy throughout thus maintaining thermocouple integrity. No dissimilar metals in the circuit.

Hex-Body Strain relief is secured by cap



Wires Jab-In™ for quick reliable hook-up of wires to 24 gage (0.020"). Strip approximately 1/4". Wire is strain-relieved with adapter or grommet

MIMS (Mineral Insulated Metal Sheathed) thermocouples are strain-relieved and held secure via optional adapters.

Hex Body

Soft insulated thermocouple alloy wire can be strain relieved and held secure via optional adapters.

SS external strain relief adapters

DESCRIPTION	TYPE	COLOR
PLUG: MINIATURE SIZE 2-POLE 	1260-T 1260-J 1260-E 1260-K 1260-K-IEC 1260-K-JIS 12601-N 2160-N-IEC 1260-R 1260-S 1260-C 1260-U	BLUE BLACK VIOLET YELLOW GREEN BLUE ORANGE PINK GREEN GREEN BROWN WHITE
JACK: MINIATURE SIZE 2-POLE 	1210-T 1210-J 1210-E 1210-K 1210-K-IEC 1210-K-JIS 1210-N 1210-N-IEC 1210-R 1210-S 1210-C 1210-U	BLUE BLACK VIOLET YELLOW GREEN BLUE ORANGE PINK GREEN GREEN BROWN WHITE

APPLICATION:

Intended for convenient plug-in connections of thermocouples and thermocouple extensions. Ideal for small diameter MIMS (Mineral Insulated Metal Sheath) and fine wire. Use for thermoelectric circuits consistent with millivolt (mV) requirements per ASTM E 1684. NOT FOR USE IN ELECTRICAL APPLICATIONS AC OR DC.

PURPOSE: To maintain the integrity of thermocouple circuits by utilizing proper thermocouple alloys and wiring techniques.

DESCRIPTION

- 2-POLE - Conforms to ASTM E 1684
- MINIATURE SIZE PLUG (POLARIZED, FLAT PINS)
- COMPATIBLE ALLOY CIRCUITRY
- TWO-PIECE: BODY / CAP
- JAB-IN™ WIRE HOOK-UP
- THERMO-SET CONSTRUCTION—WILL NOT MELT
 - Low outgassing
 - Utilization Temperature: Standard Plugs/Jacks
 - Continuous Use Temperature to 400°F (205°C)
 - Intermittent Temperature Limit 500°F (260°C)
- ASTM/IEC/DIN/JIS/INDUSTRY COLOR CODES
- THERMOCOUPLE TYPE DESIGNATION ON BODY
- POLARITY MOLDED INTO BODY
- SOFT-INSULATED WIRE SIZE TO 24 GAGE (0.020") (0.5mm)
- INTERNAL STRAIN RELIEF (Hex Body for up to 1/8"(3mm) sheath)
- EXTERNAL STRAIN RELIEF HARDWARE AVAILABLE

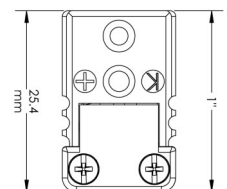
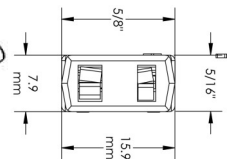
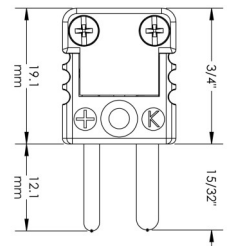
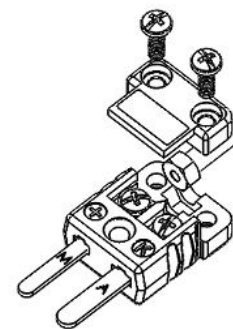
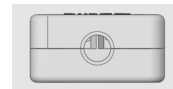

Plug, Mini 1260-X
X = Thermocouple type designation

Jack, Mini 1210-X
X = Thermocouple type designation

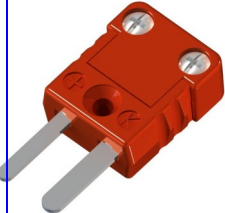
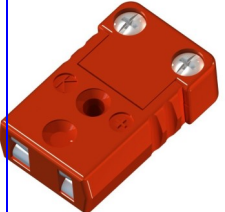
DESCRIPTION	TYPE	COLOR
PLUG: MINIATURE SIZE, HIGH-TEMP, 1360-() 	1360-T 1360-J 1360-E 1360-K 1360-N 1360-R 1360-S 1360-C 1360-U	HT-RED
JACK: MINIATURE SIZE, HIGH-TEMP 1310-() 	1310-T 1310-J 1310-E 1310-K 1310-N 1310-R 1310-S 1310-C 1310-U	HT-RED

APPLICATION:

Intended for convenient plug-in connections of thermocouples and thermocouple extensions. Ideal for small diameter MIMS and fine wire. Suitable for high temperature and/or vacuum applications. Use for thermoelectric circuits consistent with millivolt (mV) requirements per ASTM E 1684. NOT FOR USE IN ELECTRICAL APPLICATIONS AC OR DC.

PURPOSE: To maintain the integrity of thermocouple circuits by utilizing proper thermocouple alloys and wiring techniques.

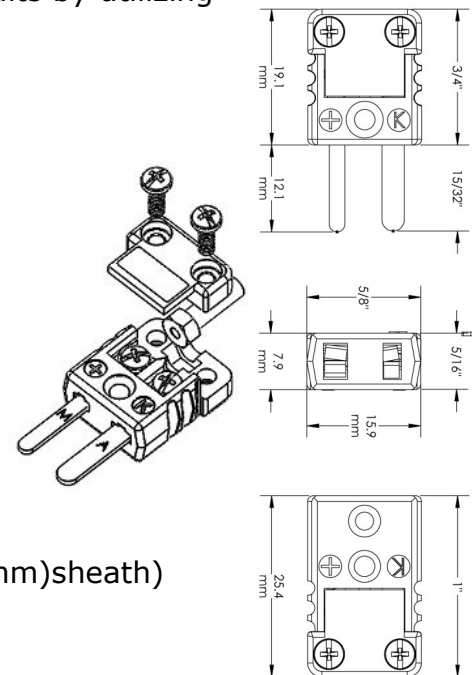

DESCRIPTION

- 2-POLE - Conforms to ASTM E 1684
- MINIATURE SIZE PLUG (POLARIZED, FLAT PINS)
- COMPATIBLE ALLOY CIRCUITRY
- TWO-PIECE: BODY / CAP
- JAB-IN™ WIRE HOOK-UP
- THERMO-SET CONSTRUCTION—WILL NOT MELT
 - Very low outgassing
 - Utilization Temperature: Standard Plugs/Jacks
 - Continuous Use Temperature to 800°F (425°C)
 - Intermittent Temperature Limit 1000°F (540°C)
- COLOR CODED (HT-RED)
- THERMOCOUPLE TYPE DESIGNATION ON BODY
- POLARITY MOLDED INTO BODY
- SOFT-INSULATED WIRE SIZE TO 24 GAGE (0.020") (0.5mm)
- INTERNAL STRAIN RELIEF (Hex Body for up to 1/8" (3mm) sheath)
- EXTERNAL STRAIN RELIEF HARDWARE

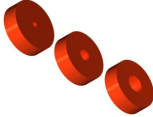

High-Temp Plug, Mini 1360-X
X = Thermocouple type designation

High-Temp Jack, Mini 1310-X
X = Thermocouple type designation

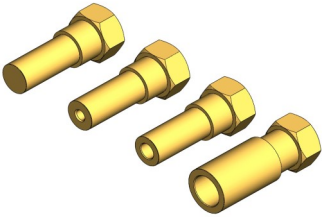
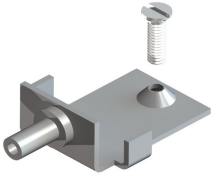
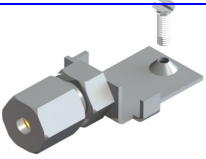
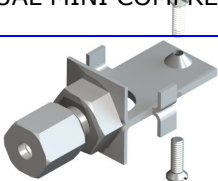
	MINI GROMMET WIRE GRIP 100/PKG	HOLE SIZE (IN)	CODE
	GRIPMINI-SMALL GRIPMINI-MEDIUM GRIPMINI-LARGE	0.030 0.062 0.090	1279-2-030 1279-2-062 1279-2-090
	MINI FLEXGRIP WIRE GRIP 100/PKG	HOLE SIZE (IN)	CODE
	FLEXGRIPMINI-SMALL FLEXGRIPMINI-MEDIUM FLEXGRIPMINI-LARGE	0.030 0.062 0.090	1278-2-030 1278-2-062 1278-2-090
	MINI WIRE CLAMP		CODE
	CLAMPWIREMINI SS		1280
	MINI HEX CRIMP SHEATH ADAPTERS	SHEATH SIZE OD INCHES	CODE
	CRIMPHEXMINI-BLANK	BLANK	1275-000-2
	CRIMPHEXMINI-1MM	0.040(1mm)	1275-040-2
	CRIMPHEXMINI-062	1/16	1275-062-2
	CRIMPHEXMINI-090	0.090	1275-090-2
	CRIMPHEXMINI-125	1/8	1275-125-2
	MINI CRIMP SHEATH ADAPTER SS	SHEATH SIZE OD INCHES	CODE
	CRIPPMINI-1MM	0.040(1mm)	1274-040
	CRIPPMINI-062	1/16	1274-062
	CRIPPMINI-090	0.090	1274-090
	CRIPPMINI-125	1/8	1274-125
	MINI COMPRESSION SHEATH ADAPTER SS	SHEATH SIZE OD INCHES	CODE
	ADAPTERMINI-1MM	0.040(1mm)	1270-040
	ADAPTERMINI-062	1/16	1270-062
	ADAPTERMINI-125	1/8	1270-125
	DUAL MINI COMPRESSION SHEATH ADAPTER SS	SHEATH SIZE OD INCHES	CODE
	ADAPTERMINIDUAL-1MM	0.040(1mm)	1271-040
	ADAPTERMINIDUAL-062	1/16	1271-062
	ADAPTERMINIDUAL-125	1/8	1271-125

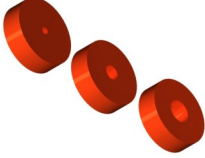
DESCRIPTION	TYPE	SIZE
GROMMET WIRE GRIP 1279-1 	1279-2-030	0.030"
	1279-2-062	0.062"
	1279-2-090	0.090"

Rated to 400°F (205°C) SILICONE RUBBER

100/PKG

Actual
Size

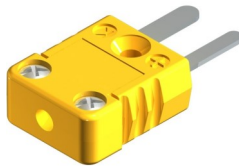

Alloy plates are designed to clamp wire without stress

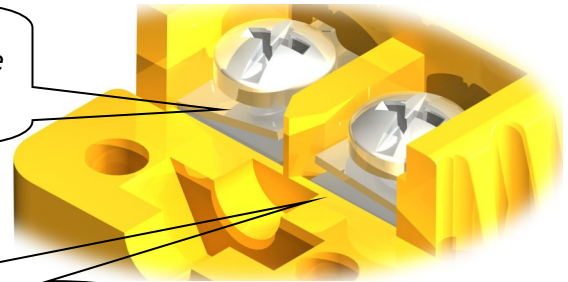

Wires Jab-In™ for quick reliable hook-up of wires to 24 gage (0.020").

Strip approximately 1/4".
INSTALL optional grommet

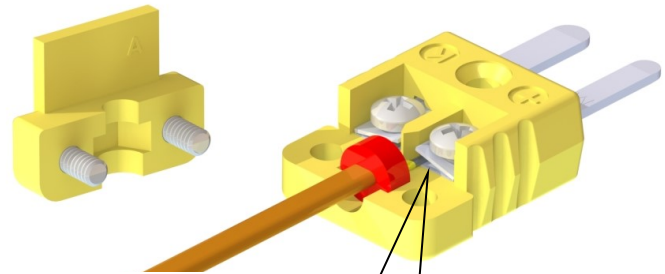
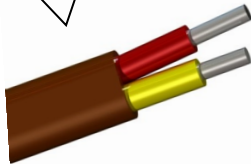

Strain relief is secured by cap

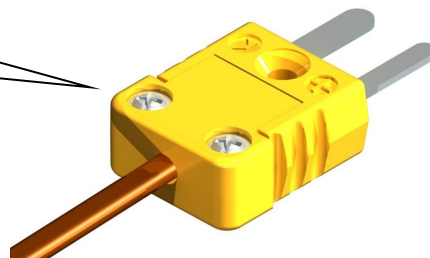

Tighten terminal screws. Jab-In terminals with compensated clamp plates will not strain wire.

DESCRIPTION	TYPE	SIZE
FLEXGRIP WIRE GRIP 1278 	1278-2-030	0.030"
	1278-2-062	0.062"
	1278-2-090	0.090"

Rated to 400°F (205°C) SILICONE RUBBER

100/PKG

Actual
Size

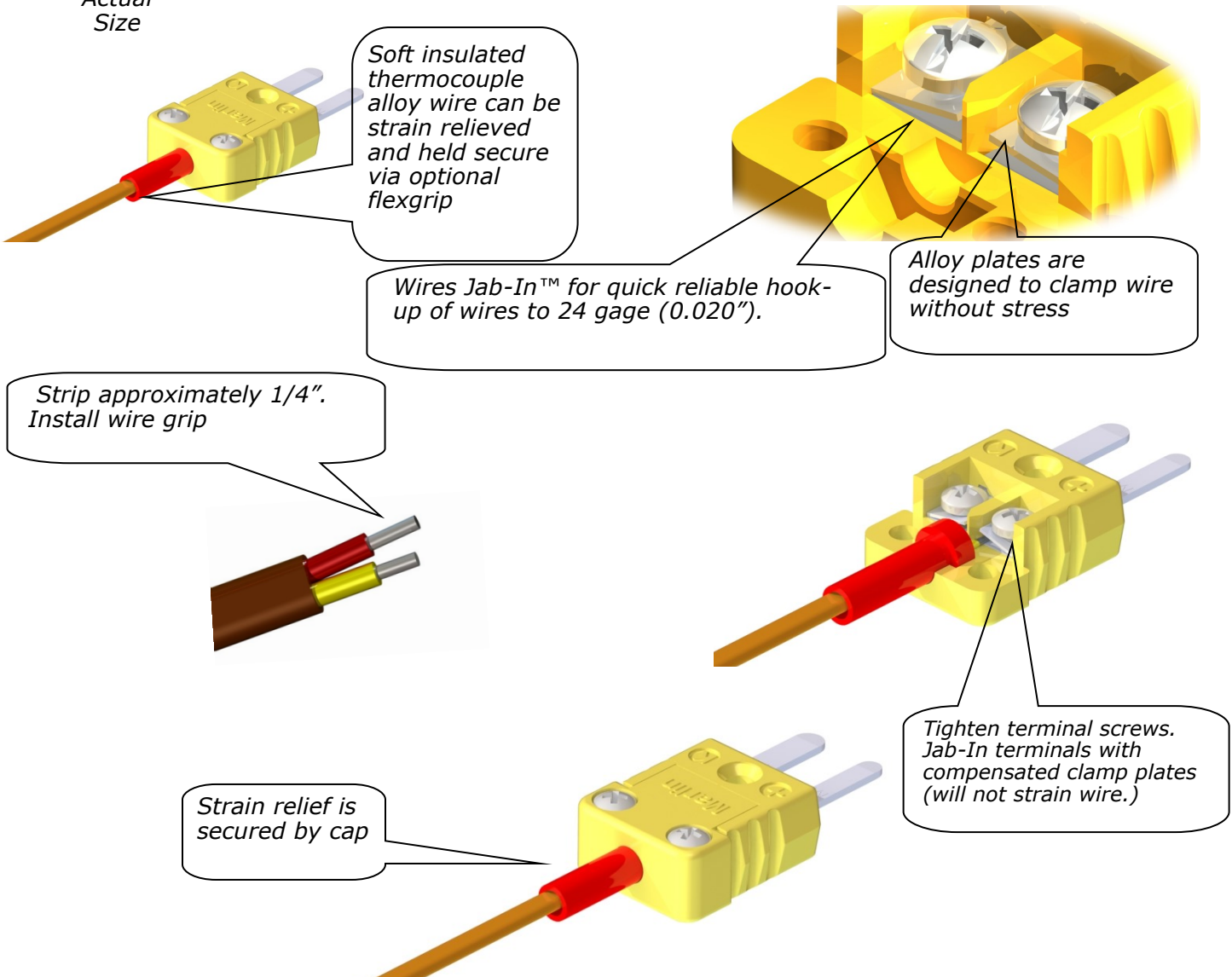

DESCRIPTION	
1280	

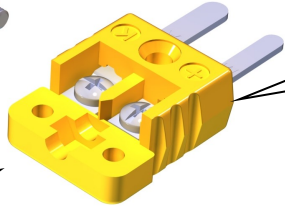
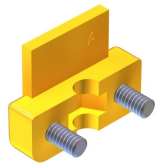
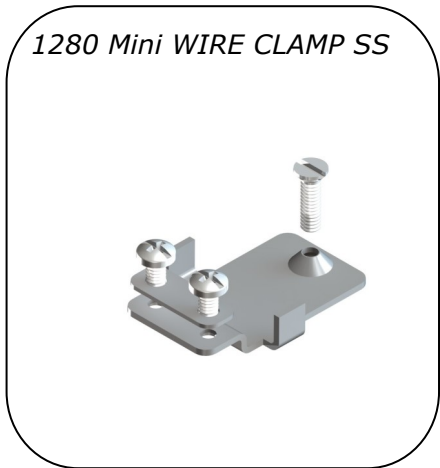

Actual Size

Miniature Connector 1260 Series

1

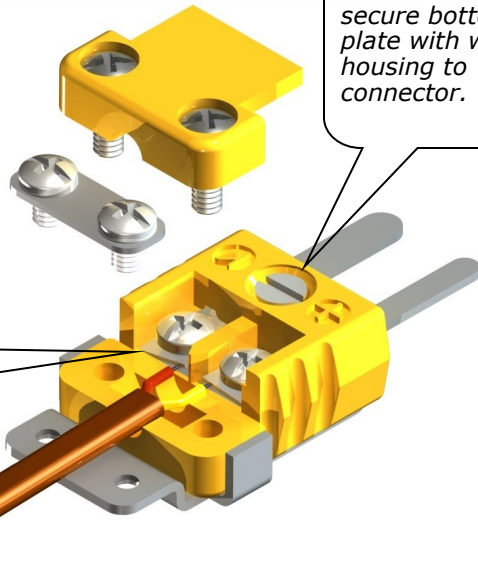

Tighten terminal screws. Jab-In terminals with compensated clamp plates will not strain wire.

Use screw to secure bottom plate with wire housing to connector.

Secure cap and plate

2

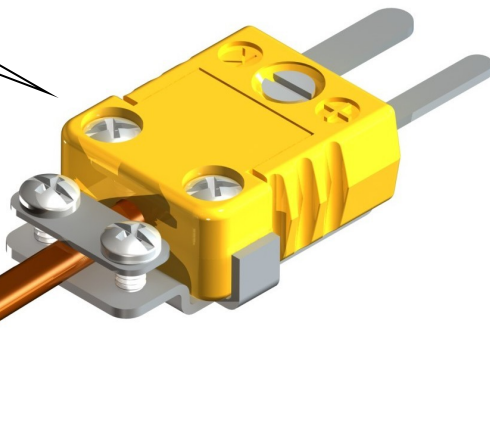

Completed, fully secured thermocouple wire

DESCRIPTION	FOR SHEATH SIZE OD INCHES
1275-000-2	BLANK
1275-020-2	0.020
1275-032-0	0.032
1275-040-2	0.040(1mm)
1275-065-2	1/16
1275-2MM-2	0.079(2mm)
1275-090-2	0.090
1275-3MM-2	0.118(3mm)
1275-125-2	1/8

1275-1 Mini Hex-Crimp Adapter
BRASS

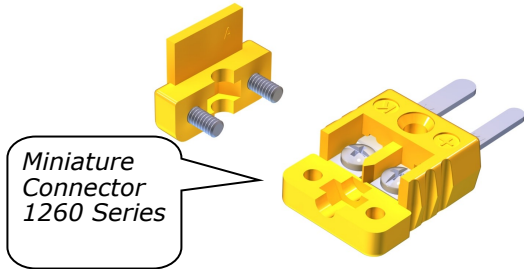
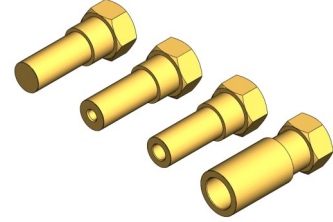

Crimp-on appropriate strain relief observing wire orientation.

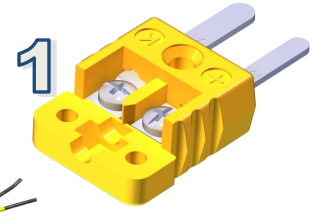

Tighten terminal screws. Jab-In terminals with compensated clamp plates will not strain wire.

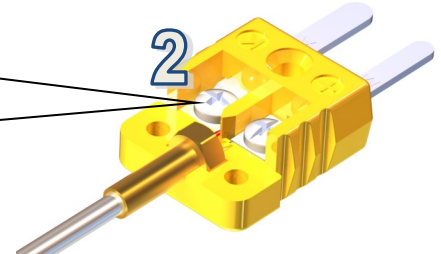

Secure cap

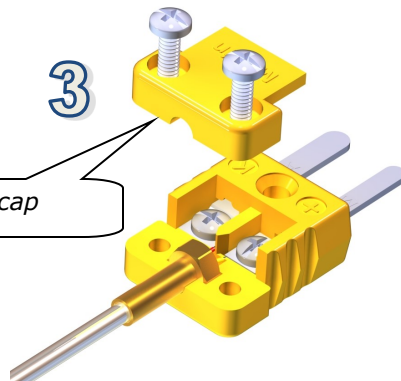

Completed, fully secured MIMS

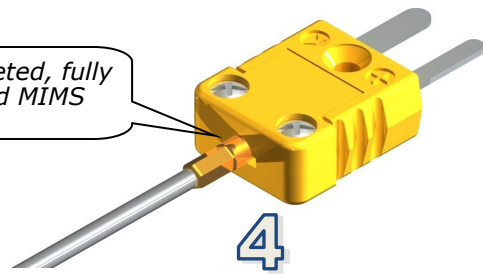

HEX-CRIMPER TOOL 1251
ORDER CODE: 10079002



DESCRIPTION	FOR SHEATH SIZE OD INCHES
1274-000	BLANK
1274-040	0.040
1274-062	1/16
1274-090	0.090
1274-125	1/8

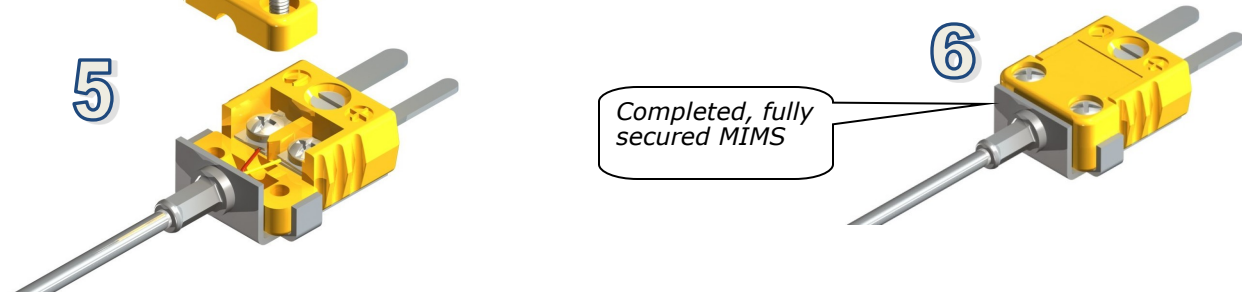
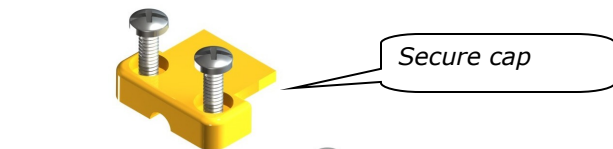
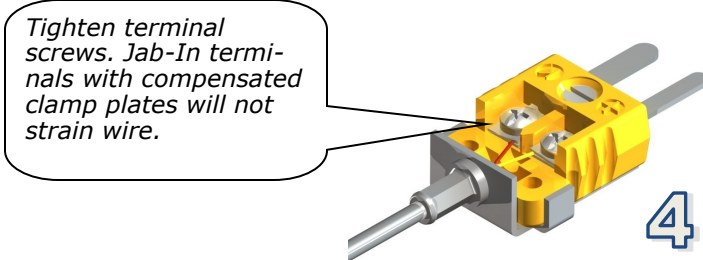
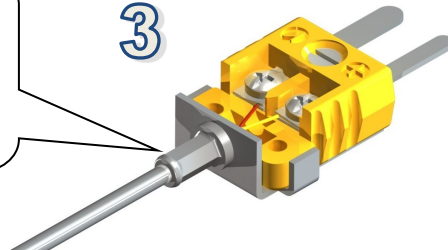
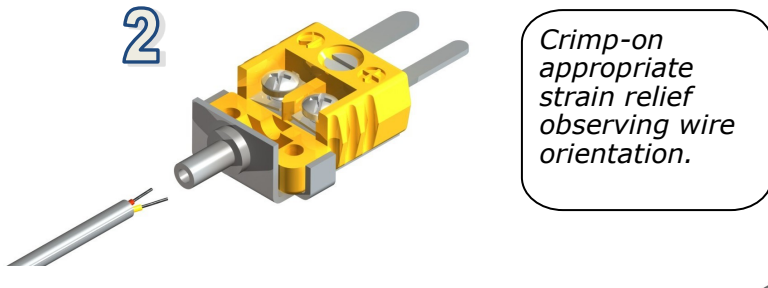
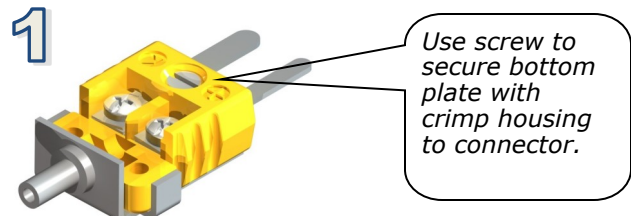
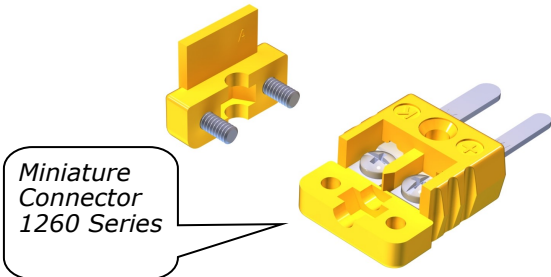

DESCRIPTION	FOR SHEATH SIZE OD INCHES
1270-040	0.040
1270-062	1/16
1270-125	1/8

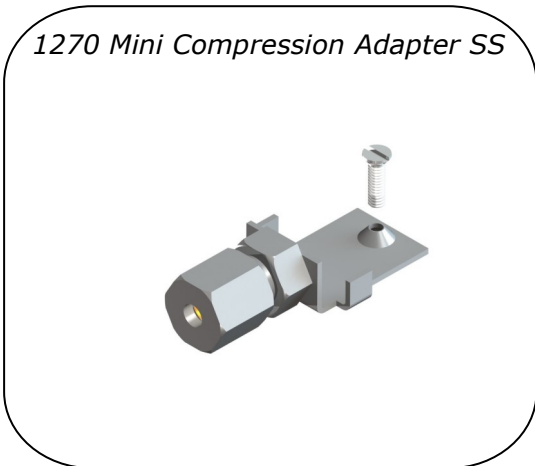

Miniature Connector 1260 Series

1

Use screw to secure bottom plate with adapter housing to connector.

2

After finger tight, compress adapter to sheath with approximately 3/4 turn

3

Tighten terminal screws. Jab-In terminals with compensated clamp plates will not strain wire.

4

5

Secure cap

6

Completed, fully secured MIMS

DESCRIPTION	FOR SHEATH SIZE OD INCHES
1271-125	1/8

1271 Mini Dual Compression Adapter SS

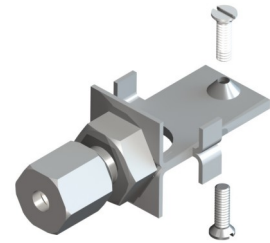

Miniature Connector 1260 Series Two required

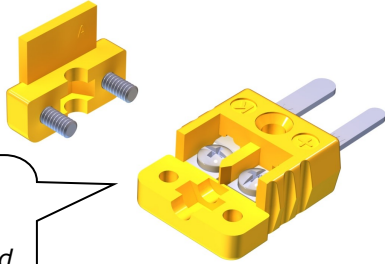

1

Use screw to secure bottom plate with adapter housing to connector.

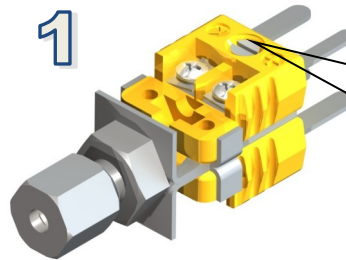

Strip sheath approximately 5/8" (0.625") (16mm)

2

After finger tight, compress adapter to sheath with approximately 3/4 turn

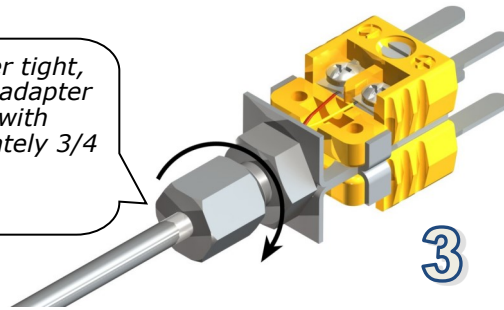
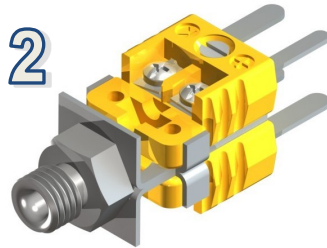
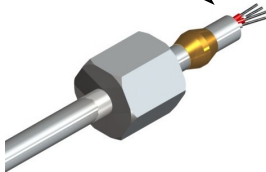

Tighten terminal screws. Jab-In terminals with compensated clamp plates will not strain wire.

4

Secure caps

5

Completed, fully secured MIMS

6

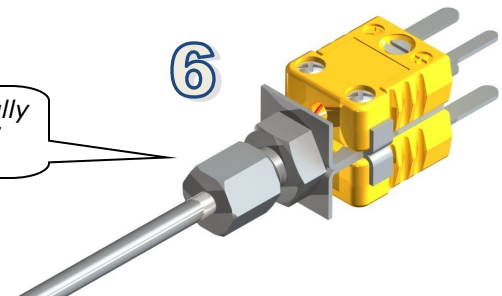
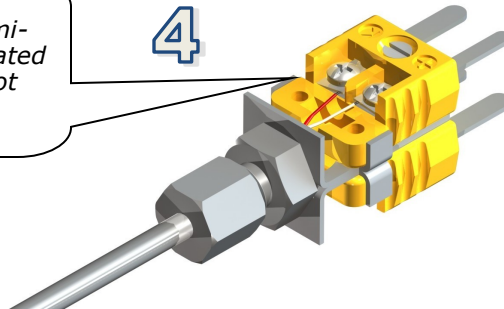
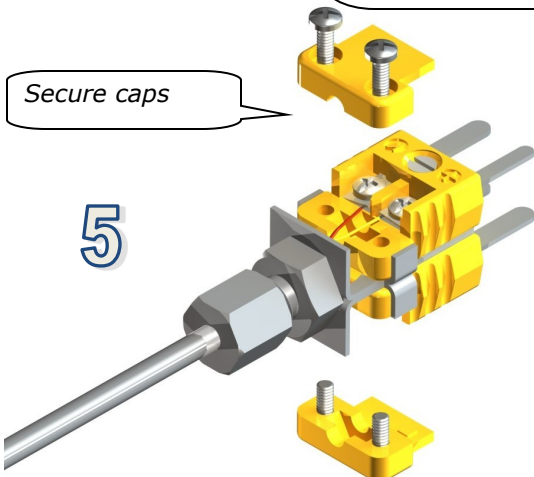

Since 1952

Marlin

**TEMPERATURE
INSTRUMENTATION**
for Research and
Industry

Quality
Performance

